

Typ
Type

97/16-407

(Art.-Nr. 1200048)

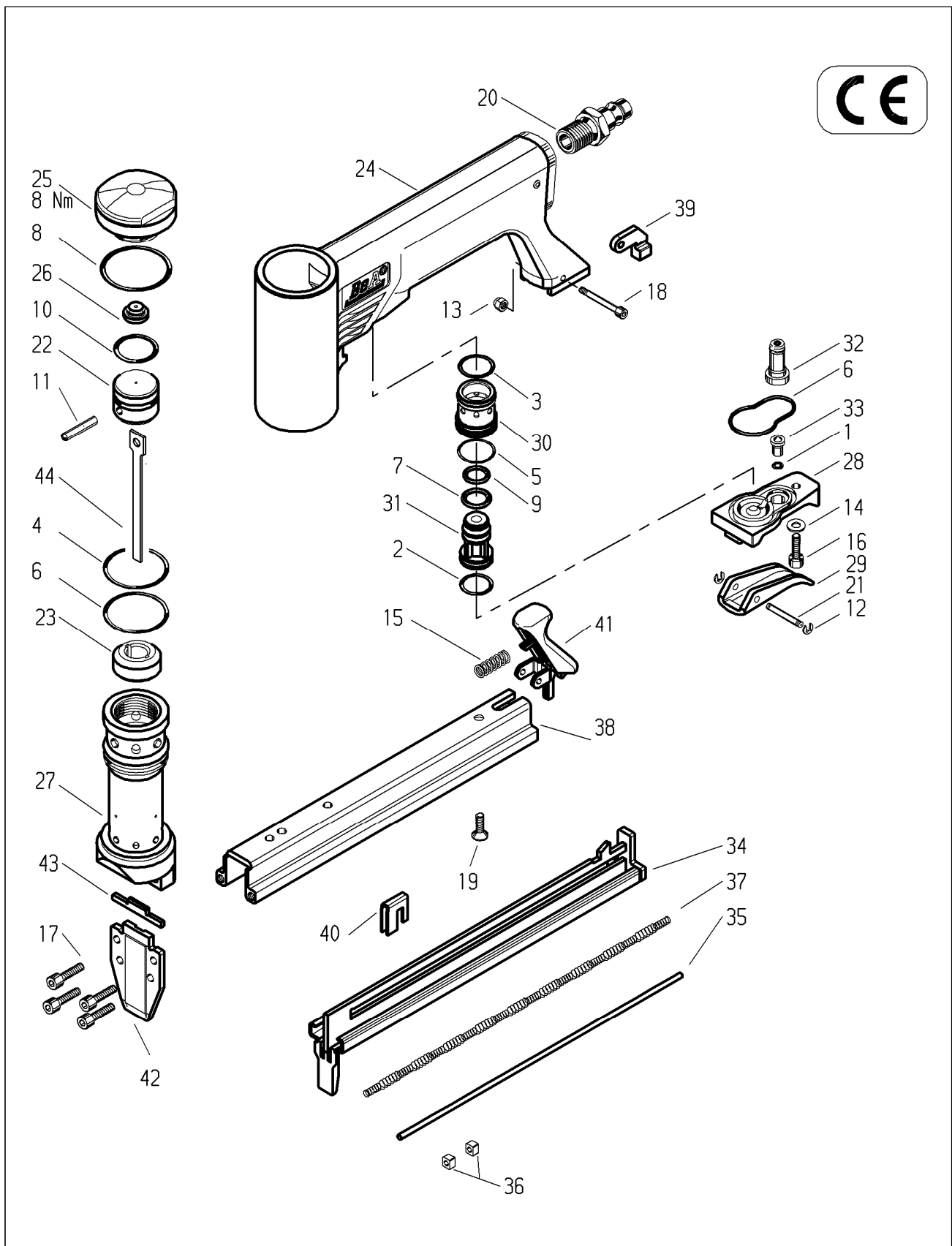

1	O-Ring	13300002	23	Puffer	14403714	35	Federführungsstange	14403810
2	O-ring	13300011		Bumper			Spring guide shaft	
3	Joint torique	13300013		Amortisseur			Tige	
4	Aro torico	13300021		Amortiguador			Vastago guia muelle	
5		13300054						
6		13300070	24	Gehäuse	14403722	36	Federabstützung	14403811
7		13300073		Body			Spring support	
8		13300082		Corps			Support de ressort	
9		13300111		Cuerpo			Soporte de muelle	
10		13300158						
11	Lagernadel	13300186	25	Kappe	14403726	37	Druckfeder	14403812
	Pin			Cap			Pressure spring	
	Axe			Capuchon			Ressort à pression	
	Eje			Cabeza			Muelle de presion	
12	Sicherungsscheibe	13300346	26	Dämpfer	14403727	38	Abdeckschiene	14403826
	Circlip			Damper			Cover	
	Clips			Amortisseur			Rail de couverture	
	Clip			Regulador			Tapa cargador	
13	Sicherungsmutter	13300436	27	Zylinder	14403728	39	Anschlag	14403815
	Safety nut			Cylinder			Stop	
	Ecrou de sûreté			Cylindre			Butoir	
	Tornillo de seguridad			Cilindro			Tope	
14	Scheibe	13300479	28	Ventilabdeckung	14403732	40	Schubkasten	14403816
	Disc			Valve cap			Feeder bar	
	Rondelle			Capuchon de soupape			Chariot	
	Arandela			Tapa valvula			Barra cargador	
15	Druckfeder	13301014	29	Auslöser	14403733	41	Sperrklinke	14403817
	Pressure spring			Trigger			Locking pawl	
	Ressort à pression			Lever de détente			Cliquet	
	Muelle de presion			Gatillo de disparo			Trinquete de cierre	
16	Zylinderschraube	13301104	30	Ventilzylinder	14403734	42	Werkzeug Teil 1	14403827
17	Allen bolt	13302683		Valve cylinder			Front nose	
18	Vis cylindrique	14400119		Cylindre de soupape			Plaque frontale	
	Tornillo allen			Valvula cilindro			Placa guia delantera	
19	Senkschraube	13302684	31	Ventilschaft	14403735	43	Werkzeug Teil 2	14403819
	Countersunk bolt			Valve shaft			Back nose	
	Vis creuse fraisée			Corps de la soupape			Plaque arrière	
	Tornillo avellanado			Vastago valvula			Placa guia posterior	
20	Anschlußnippel	14000244	32	Zwischenhülse	14403736	44	Treiber	14403828
	Air hose connector			Cylinder, intermediate valve			Driver blade	
	Embout de raccordement			Arbre intermédiaire			Marteau	
	Conector de aire manguera			Valvula intermedio cilindro			Lengueta	
21	Achse	14400118	33	Schaltstift	14403738			
	Pin			Valve pin				
	Axe			Bouton de commande				
	Eje			Pasador valvula				
22	Kolben	14403712	34	Unterschieber	14403809			
	Piston			Back nose assembly				
	Piston			Chargeur				
	Piston			Guia				